

CAMERETTA DISPEZIONE FOGNATURA BIANCA

SCALA 1:20

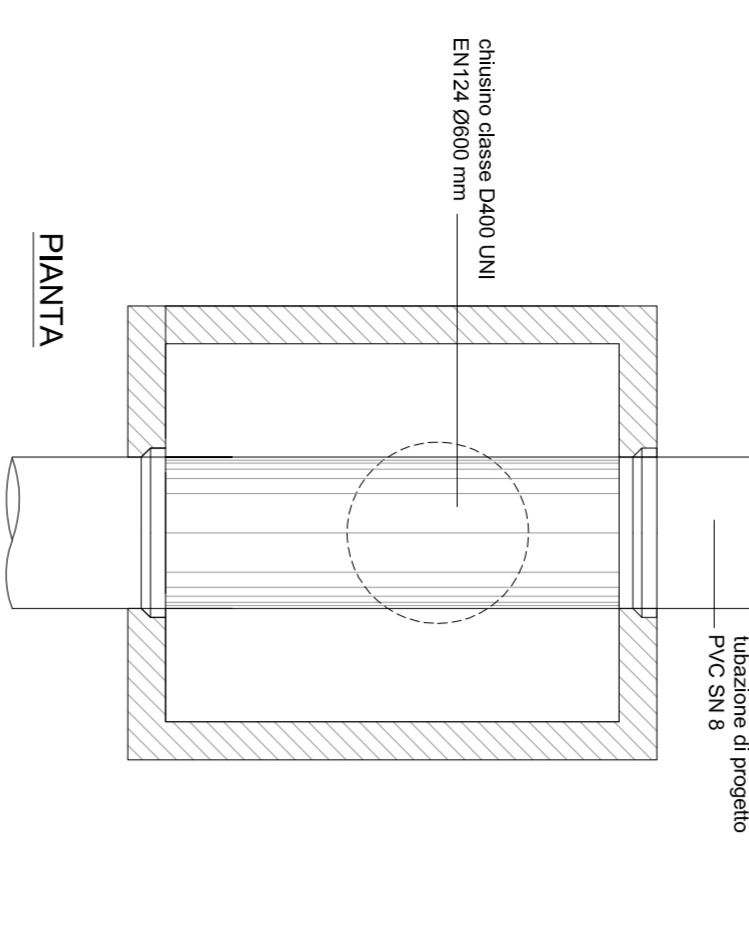
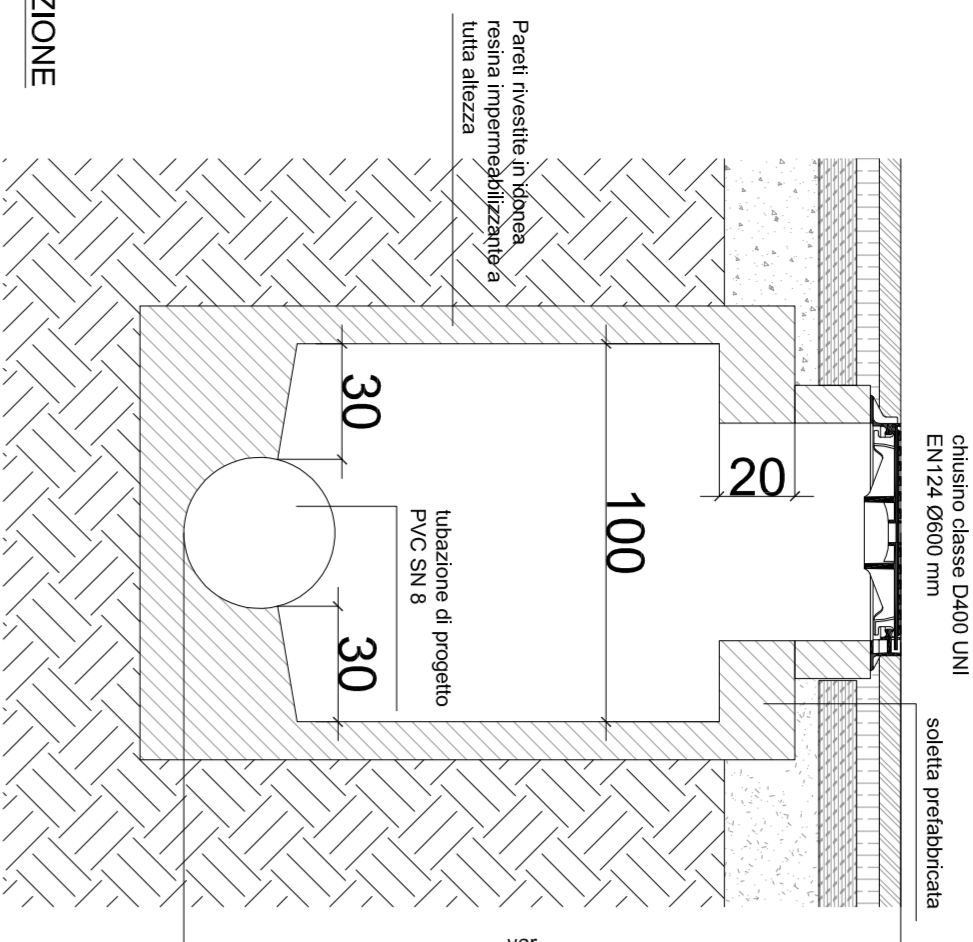

CAMERETTA DISPEZIONE FOGNATURA NERA

SCALA 1:20

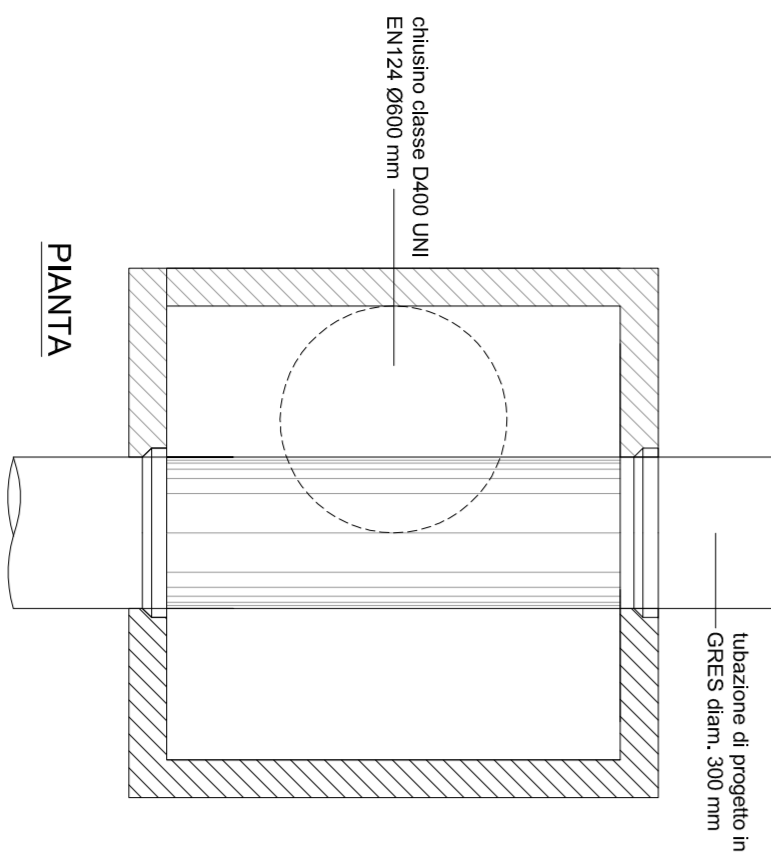
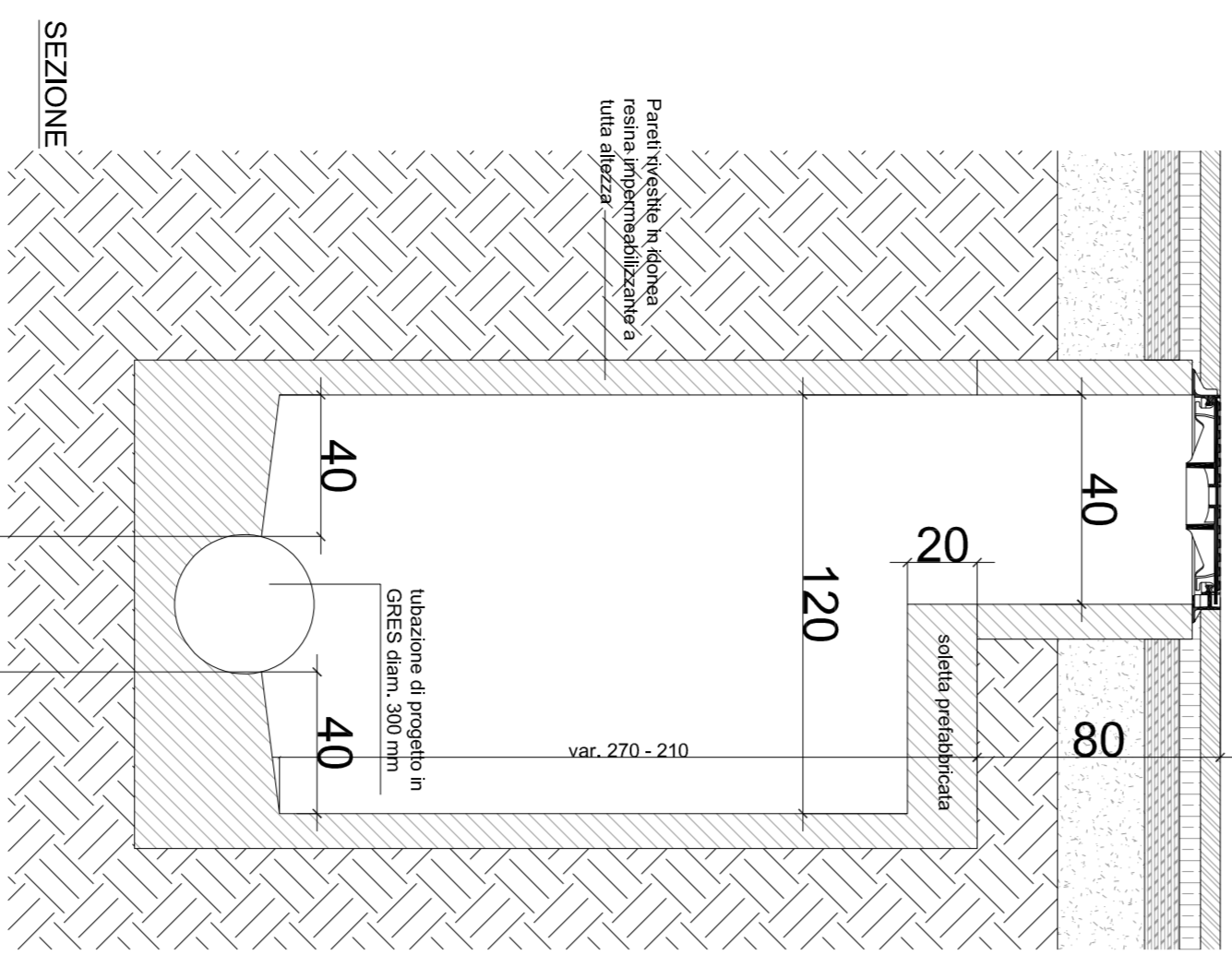

CANTONIA STRADALE

SCALA 1:20

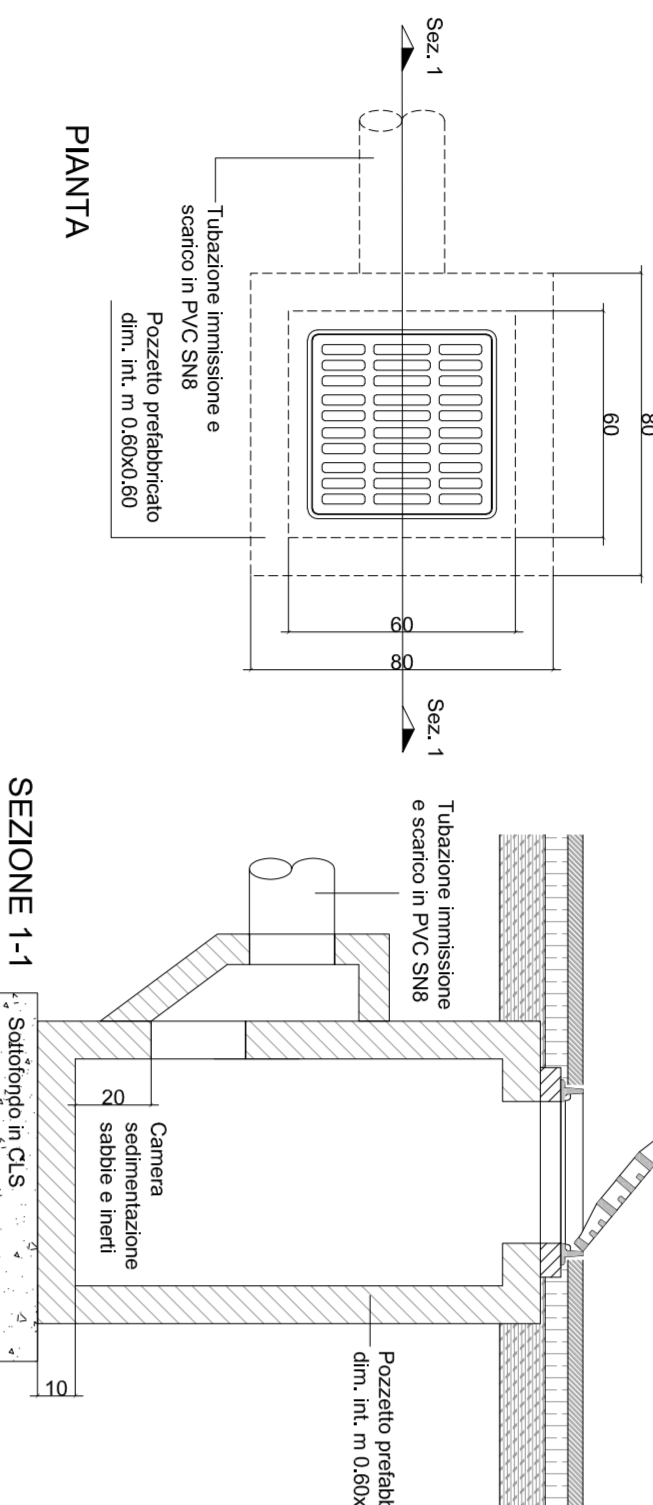

TABACCHINO PER FOGNATURA BIANCA

SCALA 1:20

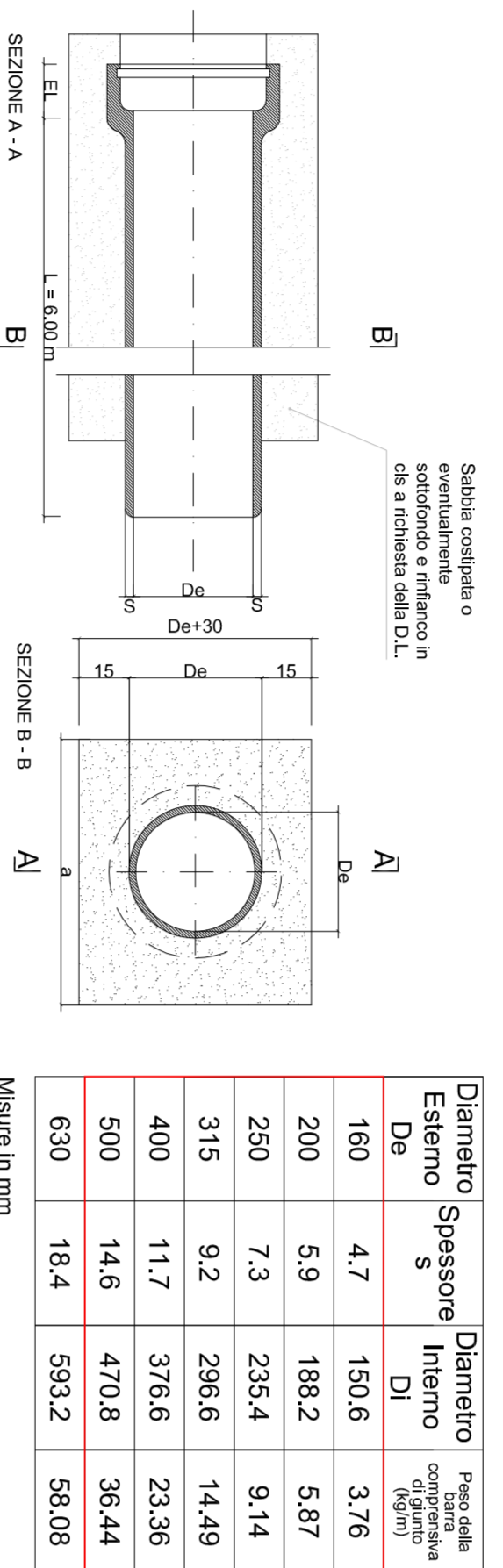

Dimensione	Spessore	Altezza	Spessore	Altezza
160	4,7	150,8	3,76	
200	5,9	188,2	5,87	
250	7,3	235,4	9,14	
315	9,2	298,6	14,49	
400	11,7	378,6	23,36	
500	14,6	471,8	38,44	
630	18,4	593,2	50,08	

**DISOLFOATORE CON FILTRO A COALESCENZA
PREFABBRICATO CARRABILE NS 15**

SCALA 1:50

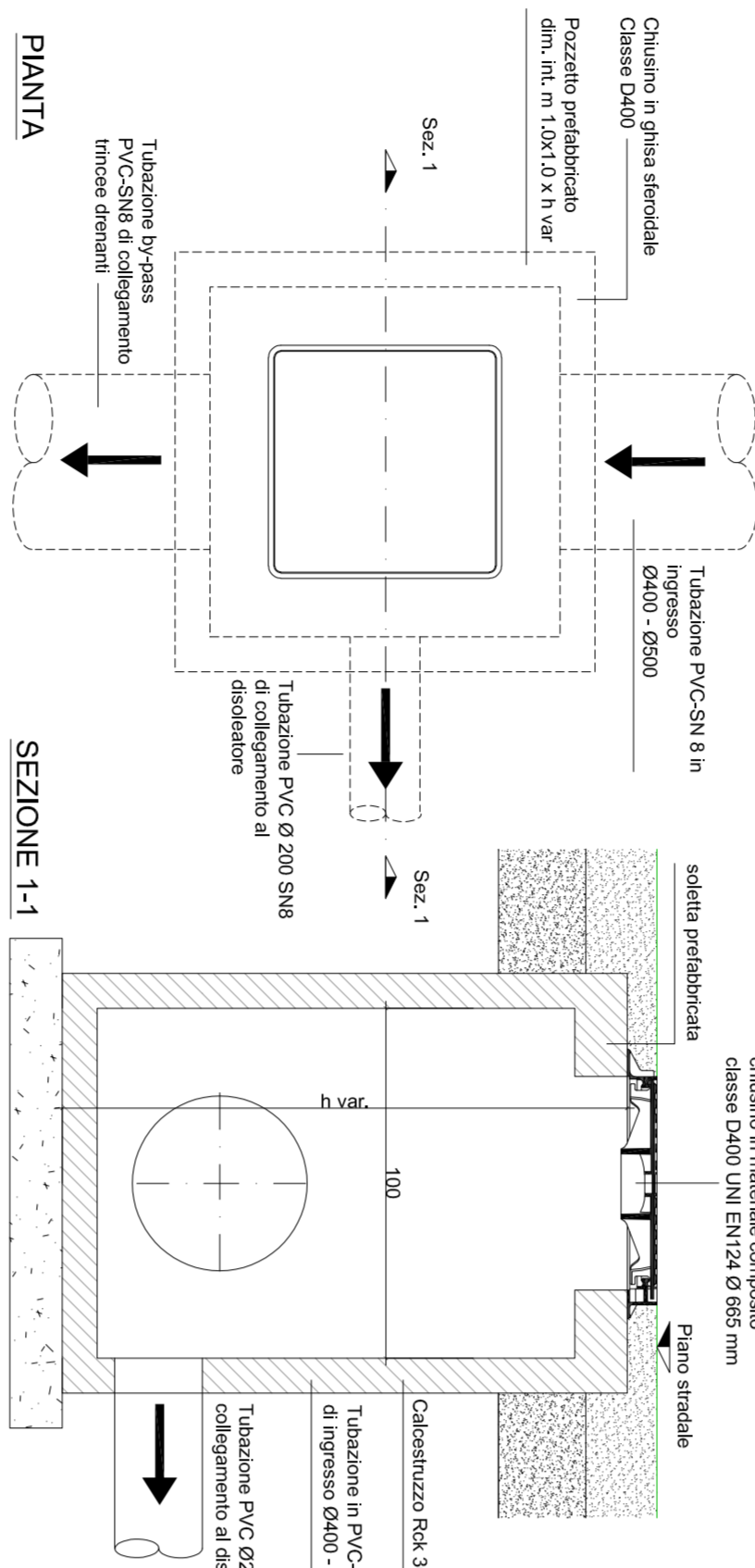
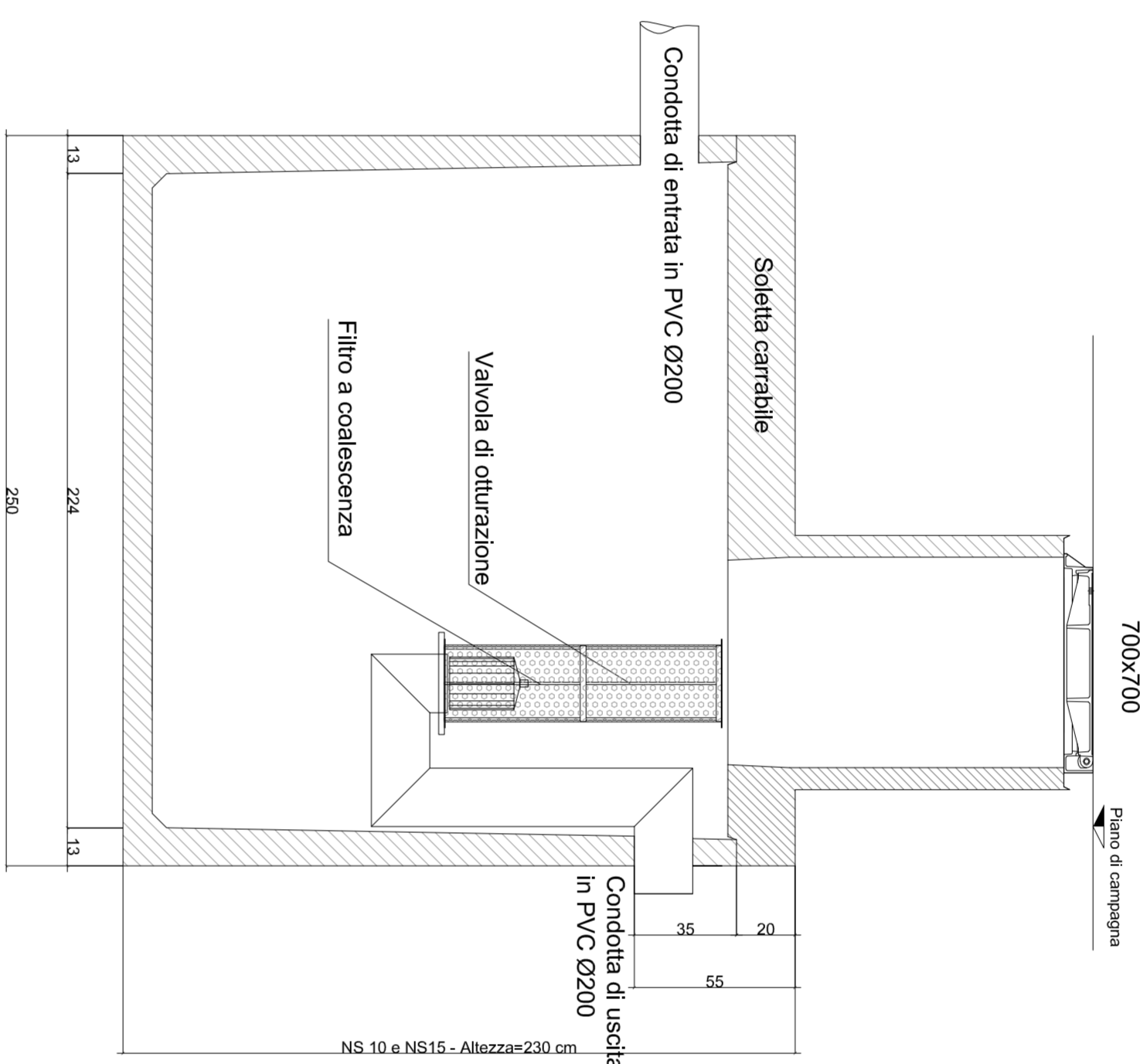

SEZIONE DI POZZA COLLETORE IN GRES Ø3000

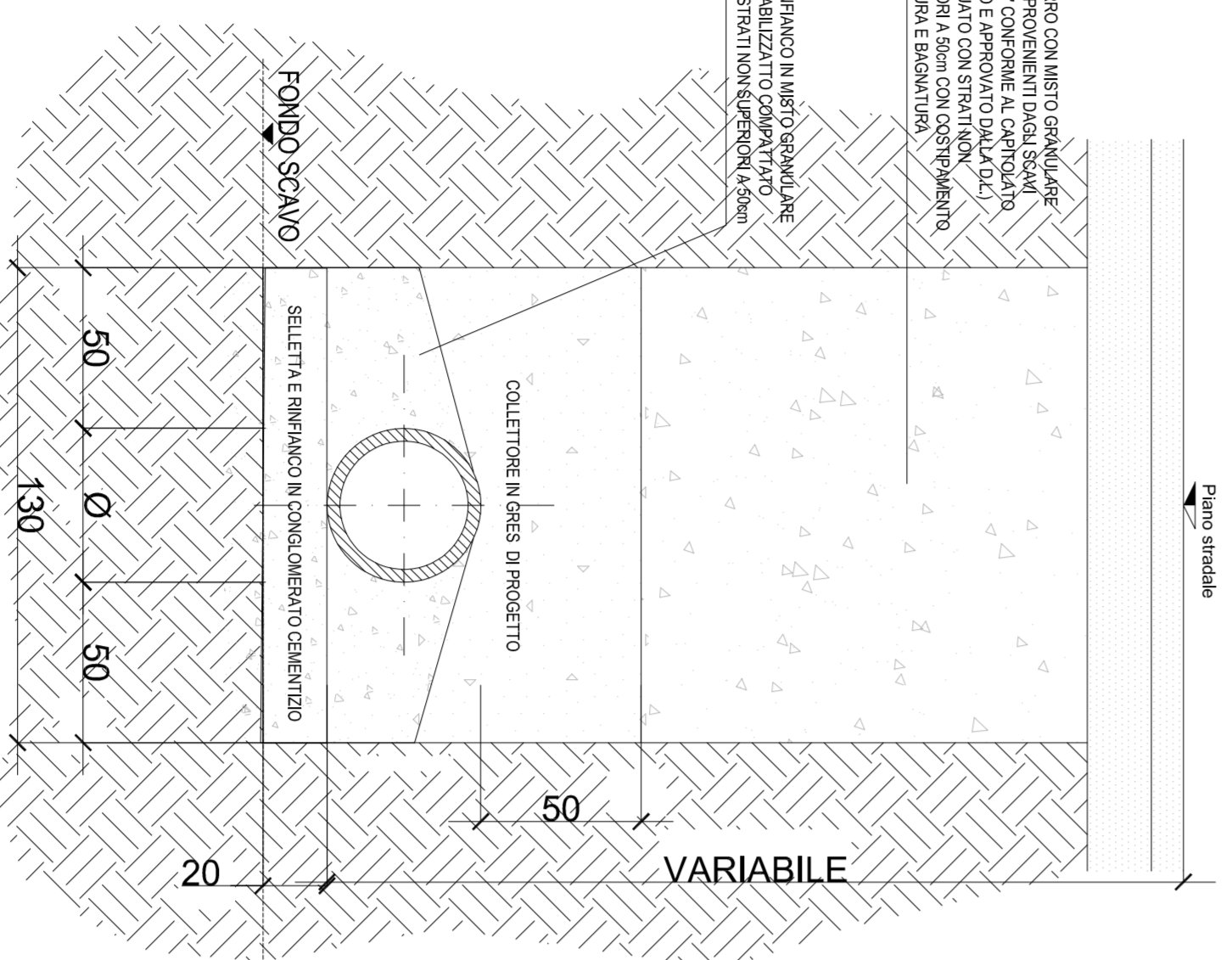

PAVIMENTAZIONE STRADA

SCALA 1:10

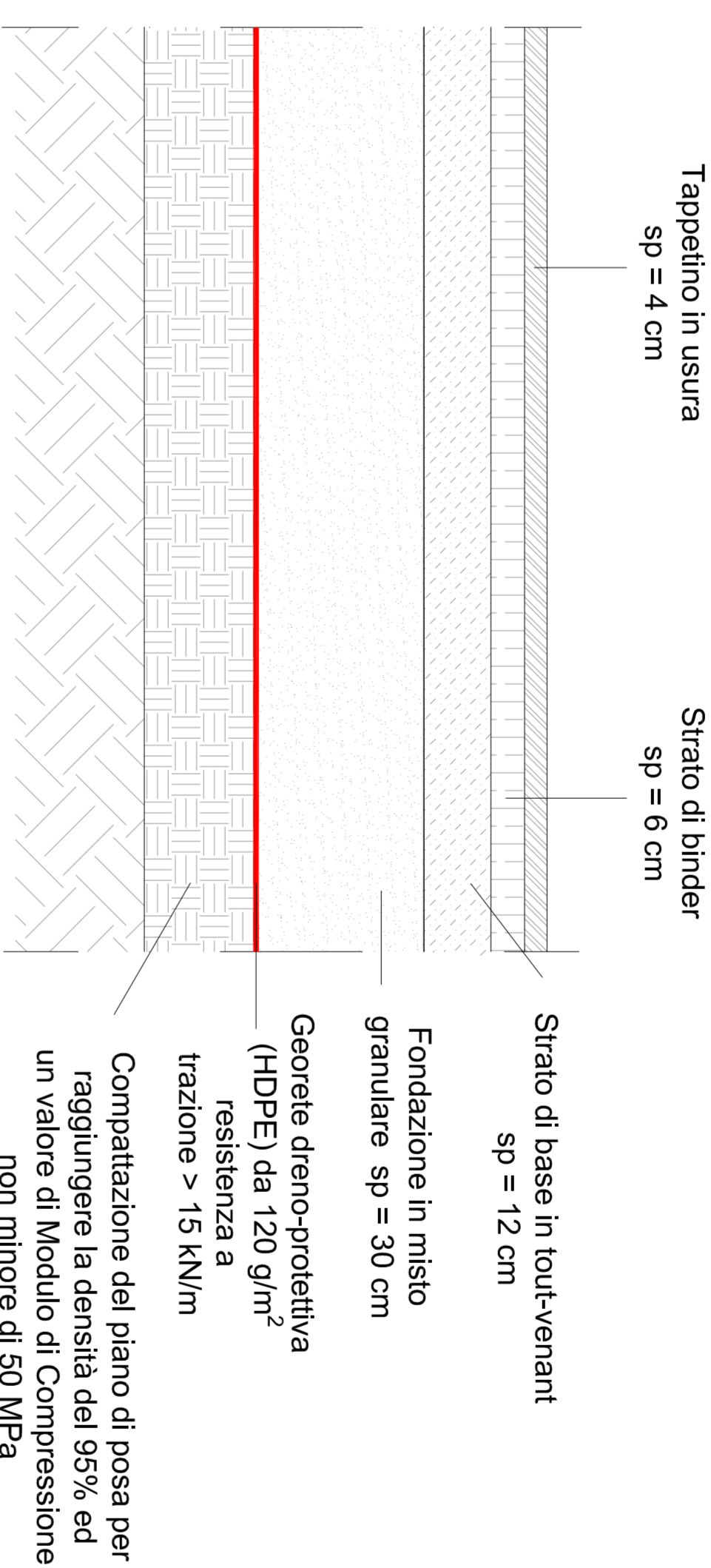

PAVIMENTAZIONE MARCIAPIEDE

SCALA 1:10

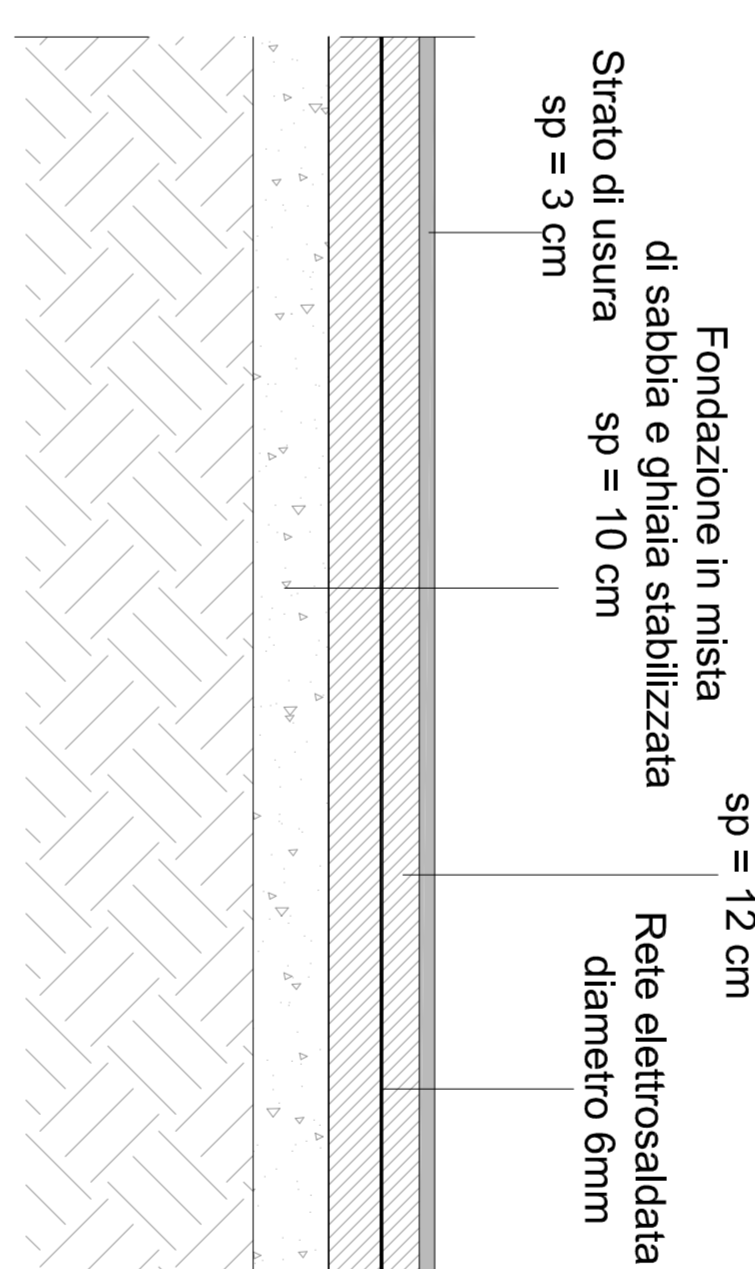

PAVIMENTAZIONE CICLABILE

SCALA 1:10

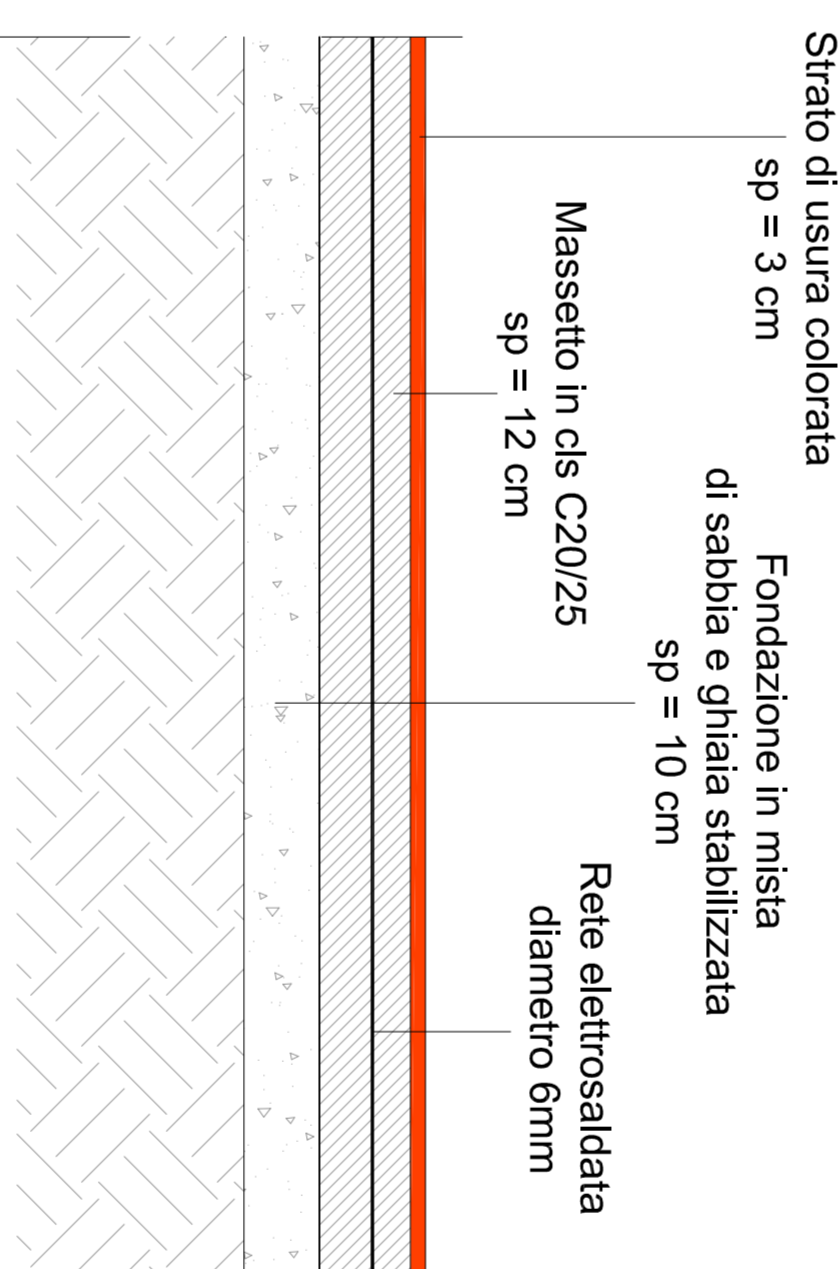

PAVIMENTAZIONE IN CIOTTOLI

SCALA 1:10

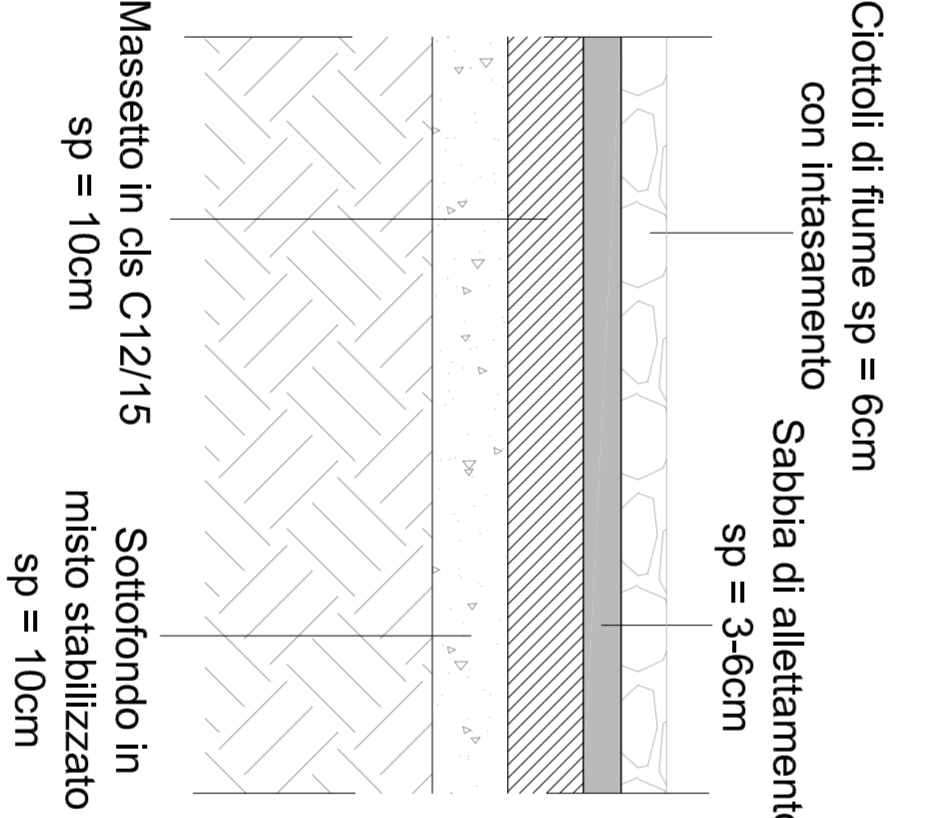

PAZZO CONICO

SCALA 1:20

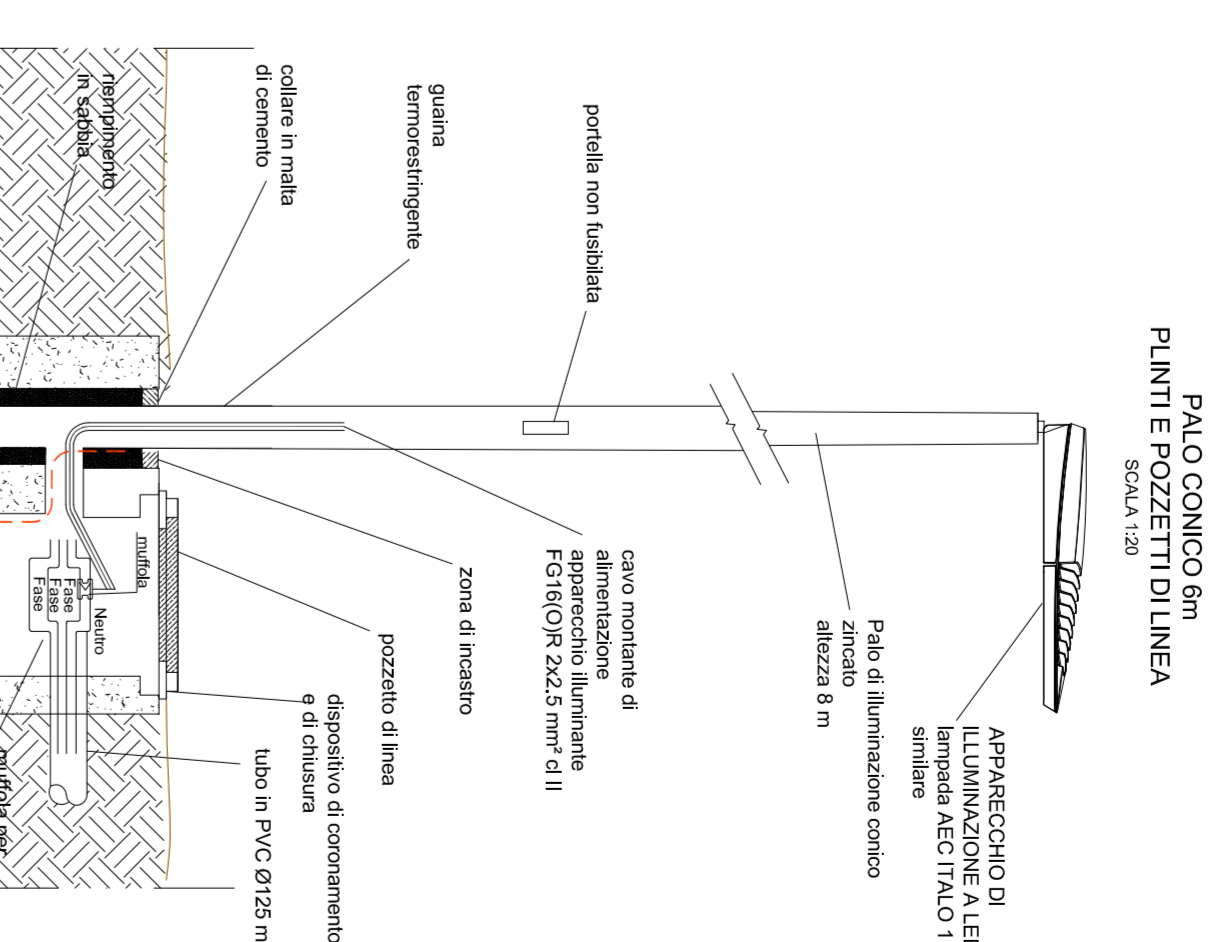

POZZETTI ILLUMINAZIONE PUBBLICA

SCALA 1:20

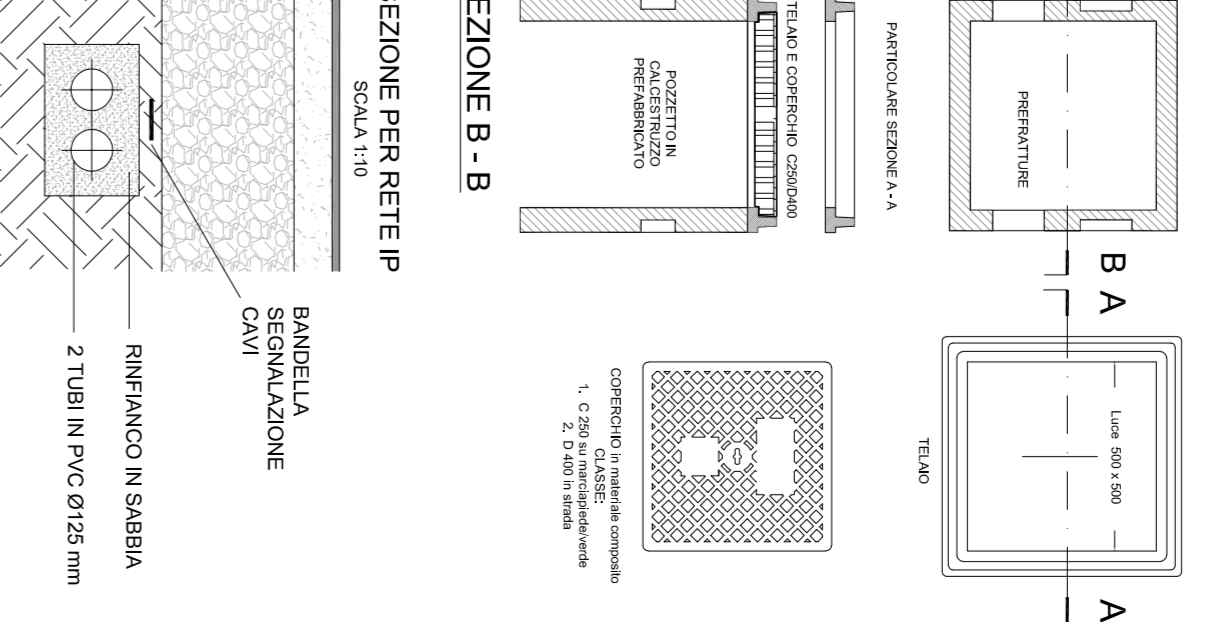

CORDOLO IN CLS 12-15x25

SCALA 1:10

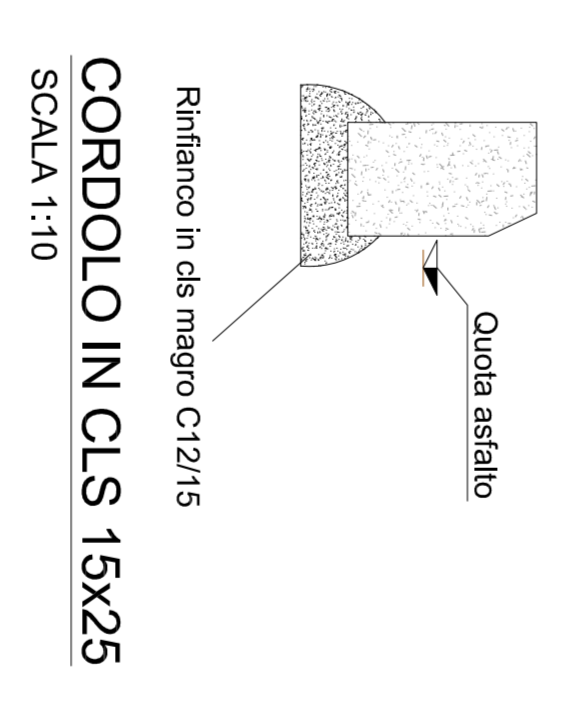

CORDOLO IN CLS 15x25

SCALA 1:10

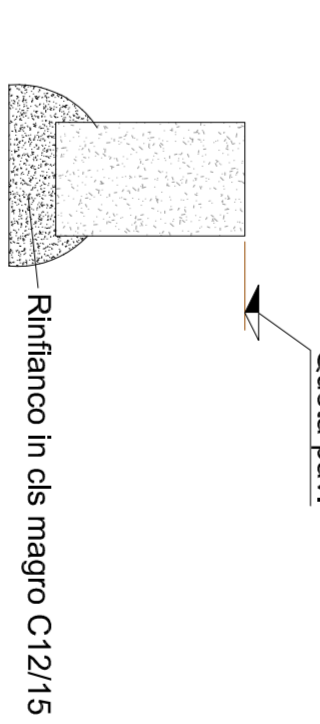

CORDOLO SORMONTABILE IN CLS

SCALA 1:10

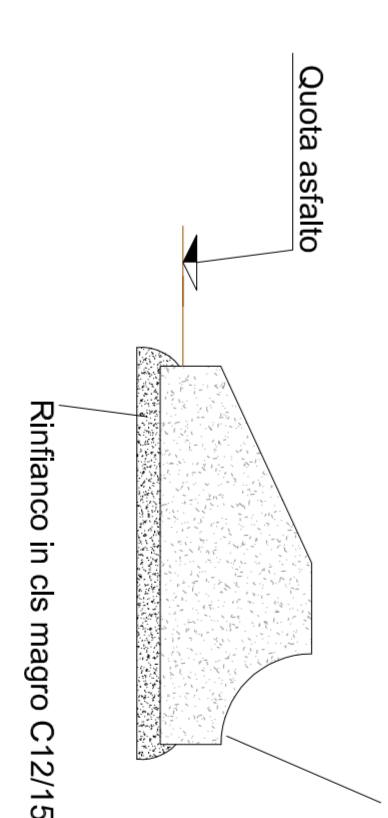

PROGETTO OFFERTA DI URBANIZZAZIONE

DETTAGLI COSTRUTTIVI

SECCATE (MI)

VARIANTE P.L.I. CENTRO PARCO LOTTO 5

APRILE 2023

1:10-20

5.4

STAMPATO NEL 2023 DAL 26

Autore: **SECCATE**

Progetto: **SECCATE (MI)**

Comune di: **SECCATE (MI)**

Progetto: **VARIANTE P.L.I. CENTRO PARCO LOTTO 5**

Scale: **1:10-20**

Stampato: **APRILE 2023**

Autore: **SECCATE**

Progetto: **SECCATE (MI)**

Comune di: **SECCATE (MI)**

Progetto: **VARIANTE P.L.I. CENTRO PARCO LOTTO 5**

Scale: **1:10-20**

Stampato: **APRILE 2023**

